

Universal Tube Clamp

Disclaimer

Please read this statement carefully and by using this product you will be deemed to have acknowledged and accepted it in full. Please check the product carefully before each use and do not use it if damaged or deformed. By using this product, you acknowledge and agree that you are fully responsible for your actions and the possible consequences of using this product. You undertake to use this product only for legitimate and lawful purposes. You understand and agree that Telesin Digital Co.,Ltd ("Telesin") shall not be liable for any misuse, adverse effects, damages, injuries, penalties or other legal consequences arising directly or indirectly from the use of this product. The user should follow the precautions including but not limited to those mentioned herein. To the extent Telesin reserves the right to interpret and modify this commitment within the limits of national laws and regulations.

Specifications

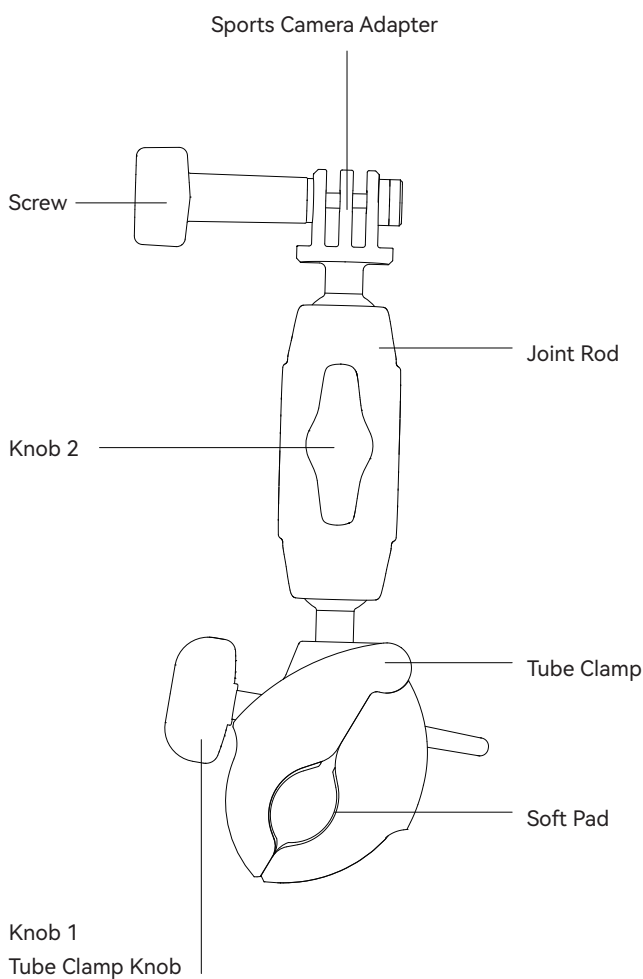

*Connect and install each accessory according to the diagram

*Please do not add any other adapters between the product and the camera, otherwise we are not responsible for any damage caused.

Before Using

- 1 Twist the clamp knob 1 until the clamp support feet are spread to the right angle and then snap onto the tubular object you wish to secure.

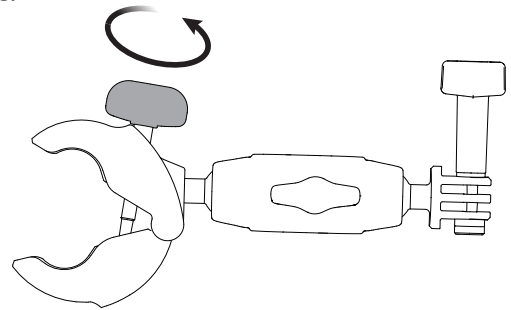

- 2 Twist the clamp knob 1 until the clamp is securely fastened to the tubular object.

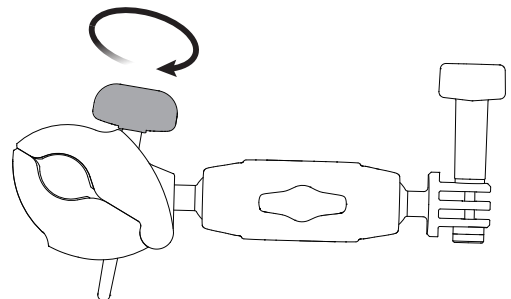

- 3 With the included silicone pad, a smaller clamping range can be achieved, with clamping diameters as small as 8-15mm. without the silicone pad, the minimum diameter of tubular objects can be clamped from 22-38mm.

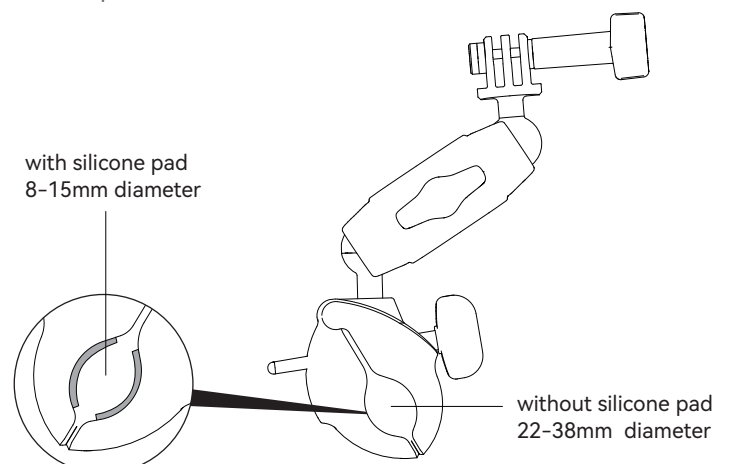

- 4 Twist the knob 2 to adjust the angle of aluminum alloy joint to achieve multi-angle shooting. (Do not force the ball head to turn while locked to avoid damage)

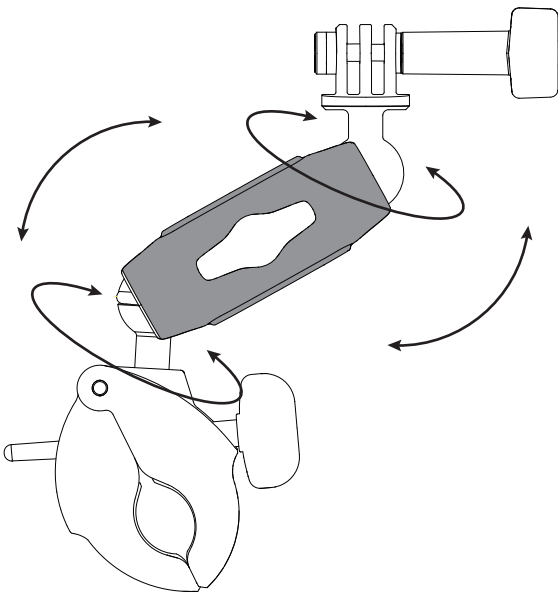
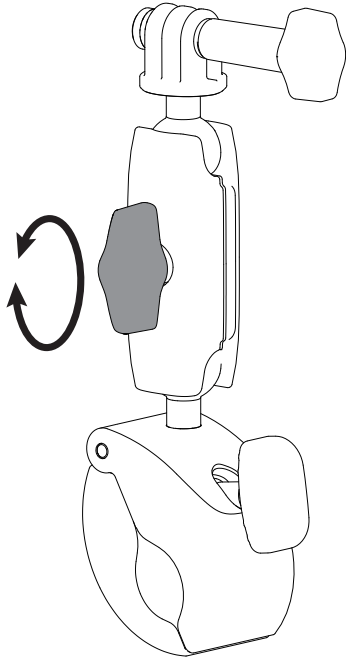

- 5 The top end of the joint can be replaced with different adapters for use, depending on the model you choose. This product comes with a sports camera adapter and a 1/4-20 screw adapter.

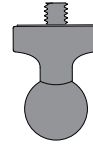

1/4-20 screw adapter (For 360Camera)

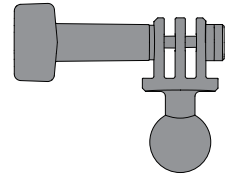

sports camera adapter

